

Outdoor Network PTZ Dome Cameras

Quick Guide

Manual Version: V1.01

Thank you for purchasing our product. If there are any questions, or requests, please do not hesitate to contact the dealer.

Copyright

Copyright 2015 Zhejiang Uniview Technologies Co., Ltd. All rights reserved. No part of this manual may be copied, reproduced, translated, or distributed in any form or by any means without prior consent in writing from our company.

Trademark Acknowledgement

 and other Uniview's trademarks and logos are the property of Zhejiang Uniview Technologies Co., Ltd. Other trademarks, company names and product names contained in this manual are the property of their respective owners.

Disclaimer



CAUTION!

The default password is used for your first login. To ensure account security, please change the password after your first login. You are recommended to set a strong password (no less than eight characters).

- To the maximum extent permitted by applicable law, the product described, with its hardware, software, firmware and documents, is provided on an "as is" basis.
- Best effort has been made to verify the integrity and correctness of the contents in this manual, but no statement, information, or recommendation in this manual shall constitute formal guarantee of any kind, expressed or implied. We shall not be held responsible for any technical or typographical errors in this manual. The

contents of this manual are subject to change without prior notice. Update will be added to the new version of this manual.

- Use of this manual and product and the subsequent result shall be entirely on your own responsibility. In no event shall we be reliable to you for any special, consequential, incidental, or indirect damages, including, among others, damages for loss of business profits, business interruption, or loss of data or documentation, or product malfunction or information leakage caused by cyber attack, hacking or virus in connection with the use of this product.
- Video and audio surveillance can be regulated by laws that vary from country to country. Check the law in your local region before using this product for surveillance purposes. We shall not be held responsible for any consequences resulting from illegal operations of the device.
- The illustrations in this manual are for reference only and may vary depending on the version or model. As a result, some of the examples and functions featured may differ from those displayed on your monitor.
- This manual is a guide for multiple product models and so it is not intended for any specific product.
- Due to uncertainties such as physical environment, discrepancy may exist between the actual values and reference values provided in this manual. The ultimate right to interpretation resides in our company.



Environmental Protection

This product has been designed to comply with the requirements on environmental protection. For the proper storage, use and disposal of this product, national laws and regulations must be observed.



Safety and Compliance Information

Safety Symbols

The symbols in the following table may be found on installation-related equipment. Be aware of the situations indicated and take necessary safety precautions during equipment installation and maintenance.

Symbol	Description
	Generic alarm symbol: To suggest a general safety concern.
	ESD protection symbol: To suggest electrostatic-sensitive equipment.
	Electric shock symbol: To suggest a danger of high voltage.

The symbols in the following table may be found in this manual. Carefully follow the instructions indicated by the symbols to avoid hazardous situations and use the product properly.

Symbol	Description
 WARNING!	Indicates a hazardous situation which, if not avoided, could result in bodily injury or death.
 CAUTION!	Indicates a situation which, if not avoided, could result in damage, data loss or malfunction to product.
 NOTE!	Indicates useful or supplemental information about the use of product.

Safety Information

Installation and removal of the unit and its accessories must be carried out by qualified personnel. Please read all of the safety instructions below before installation and operation.

Installation

- This device is a class A product and may cause radio interference. Take measures if necessary.

- If the product does not work properly, please contact your dealer. Never attempt to disassemble the camera yourself. (We shall not assume any responsibility for problems caused by unauthorized repair or maintenance.)
- While shipping, the camera should be packed in its original packing.
- Make sure the power supply voltage is correct before using the camera.
- Do not drop the camera or subject it to physical shock.
- Do not touch sensor modules with fingers. If cleaning is necessary, use a clean cloth with a bit of ethanol and wipe it gently. If the camera will not be used for an extended period of time, put on the lens cap to protect the sensor from dirt.
- Do not aim the camera lens at the strong light such as sun or incandescent lamp. The strong light can cause fatal damage to the camera.
- The sensor may be burned out by a laser beam, so when any laser equipment is being used, make sure that the surface of the sensor not be exposed to the laser beam.
- Use the waterproof tapes to protect the end of tail cable, and keep the tail cable from water.
- Mount a laser dome camera at a height of six meters (19.7 ft) from the ground. To avoid bodily injury from the laser radiation, please make sure that no one is within the range of three meters from the camera when the laser is working.
- Keep the device from pressure, vibration, and moisture during transportation, storage, and installation. Keep the device away from any source of vibration during installation.
- Use a power adapter or a PoE device that meets requirements. Otherwise, the device may be damaged.
- Keep the length of the power cable between the power adapter and the device within 1.5 meters, otherwise, the power voltage on

the device may be lowered and may cause exception. If the power cable is not long enough, extend the part between the power adapter and the power supply.

- Disconnect power before you move the device. The device is instantly electrified when the power cable is plugged in.
- Do not move the device by lifting the tail cable.
- Do not cut the tail cables. Exposed tail cables can cause short circuit and damage the device.
- Use the power cable connector delivered with the device. Make sure the connector is in good condition (clip) and secured into place. Do not fully stretch the power cord, otherwise, the connector may loose or be disconnect due to vibration or shake.
- The end of the tail cable must be kept under good protection. Take waterproof measures to protect tail cables, and keep away from water.
- Make sure that the ceiling or wall can bear the weight of your camera.
- During the process of transportation, special attention is required for the protection of the front glass surface to prevent friction, scratch and contamination, etc. In order to keep the front glass clean, do not remove the protective film on the front glass surface during mounting. After mounting is finished, remove the film before the device is powered on.

Maintenance

- If there is dust on the front glass surface, remove the dust gently using an oil-free brush or a rubber dust blowing ball.
- If there is grease or a dust stain on the front glass surface, clean the glass surface gently from the center outward using anti-static gloves or an oil-free cloth. If the grease or the stain still cannot be removed, use anti-static gloves or an oil-free cloth dipped with detergent and clean the glass surface gently until it is removed.

- Do not use organic solvents, such as benzene or ethanol when cleaning the front glass surface.
-



WARNING!



- Never look at the transmit laser while the power is on. Never look directly at the fiber ports and the fiber cable ends when they are powered on.
 - Use of controls or adjustments to the performance or procedures other than those specified herein may result in hazardous laser emissions.
-

Regulatory Compliance

FCC Part 15

This equipment has been tested and found to comply with the limits for digital device, pursuant to part 15 of the FCC Rules. These limits are designed to provide reasonable protection against harmful interference when the equipment is operated in a commercial environment. This equipment generates, uses, and can radiate radio frequency energy and, if not installed and used in accordance with the instruction manual, may cause harmful interference to radio communications. Operation of this equipment in a residential area is likely to cause harmful interference in which case the user will be required to correct the interference at his own expense.

This product complies with Part 15 of the FCC Rules. Operation is subject to the following two conditions:

1. This device may not cause harmful interference.
2. This device must accept any interference received, including interference that may cause undesired operation.

LVD/EMC Directive



This product complies with the European Low Voltage Directive 2006/95/EC and EMC Directive 2004/108/EC.

WEEE Directive–2002/96/EC



The product this manual refers to is covered by the Waste Electrical & Electronic Equipment (WEEE) Directive and must be disposed of in a responsible manner.

Contents

1 Appearance Description.....	1
Dimensions.....	1
Cable Connection	2
2 Mount Your Camera	4
Preparations.....	4
Check Before Mount.....	4
Cable Requirements	5
Process Map	9
Hardware Installation	11
Insert the Micro SD Card (Optional)	11
Mount the SFP Optical Module	12
Mount the Camera	14
Start the Camera.....	19
Reset the Camera to Default Settings.....	20
Waterproof Measures.....	21
Waterproof Components for an RJ45 Plug.....	21
Waterproof Tail Cable.....	22
3 Set Your Camera over the LAN	25
4 Access Your Camera.....	26
System Requirements for Your PC.....	26
Access Your Camera	26
Install the ActiveX	27
Adjust the Display	28

1 Appearance Description

Dimensions

Dimensions of network dome cameras are as follows. For the actual appearance, see the product.

Table 1-1 Dimensions

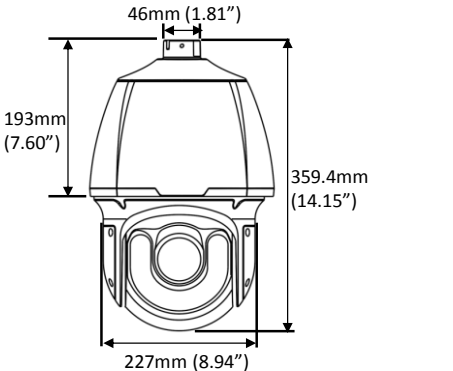
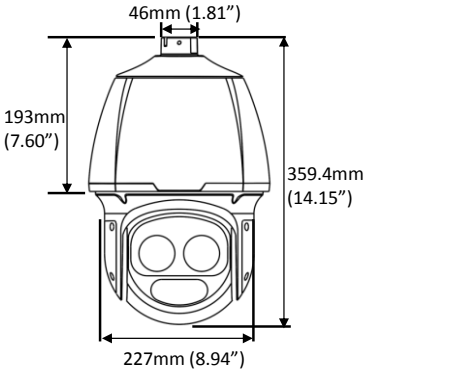
Model	Dimensions
<ul style="list-style-type: none"> • IR PTZ Dome (for long range illumination) • Smart IR PTZ Dome • Starlight White Light PTZ Dome • Starlight Full Spectrum PTZ Dome • Starlight IR PTZ Dome 	 <p>Technical drawing of a PTZ dome camera showing dimensions: 46mm (1.81") top width, 193mm (7.60") height to the top of the dome, 227mm (8.94") bottom width, and 359.4mm (14.15") total height.</p>
<p>Laser PTZ Dome</p>	 <p>Technical drawing of a Laser PTZ dome camera showing dimensions: 46mm (1.81") top width, 193mm (7.60") height to the top of the dome, 227mm (8.94") bottom width, and 359.4mm (14.15") total height.</p>

Model	Dimensions
IR PTZ Dome (for short range illumination)	<p>46mm (1.81")</p> <p>193mm (7.60")</p> <p>359.4mm (14.15")</p> <p>227mm (8.94")</p>

Cable Connection

All cables are tagged to indicate their functions separately. The cables available may vary with the product model. The following takes full cable as an example.



NOTE!

- Certain models support Ethernet interface (10M/100M Base-TX Ethernet, RJ45).
- Certain models support optical interface (SFP module) and FC fiber connector (fiber optical adapter included).
- The dome camera is delivered without the SFP optical module installed. For the details about mounting the optical module, see [Mount the SFP Optical Module](#).
- Please disconnect the power before mounting. You can connect the camera to the network through the optical interface or the copper interface after mounting and switch two interfaces without disconnecting the power. The two interfaces cannot be used at the same time.
- For the detailed information about the specifications, see the datasheet.

Figure 1-1 Cable Connection

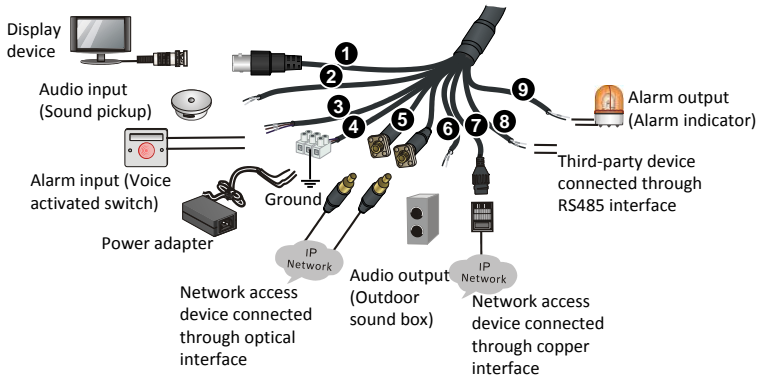

Table 1-2 Description About Interfaces of Full Tail Cable

No.	Interface	Function
①	VIDEO OUT	Video output interface. Output video signals and connect to analog devices such as monitors for video display.
②	AUDIO IN	Audio input interface. Input audio signals or performs intercom. Note: Audio input and intercom cannot be used at the same time with this interface.
③	ALARM IN	Alarm input interface. Input alarm signals.
④	Power interface	Connect to the power adaptor.
⑤	Optical interface	100M/1000M Base-FX adaptive SFP module. Connect to the optical network. Note: The optical is single mode fiber. See Optical fiber for more information.
⑥	AUDIO OUT	Audio output interface. Output audio signals.
⑦	Ethernet interface	10M/100M Base-TX adaptive Ethernet interface. Connect to the network.

No.	Interface	Function
⑧	RS485	Serial port. Interact and control an external device. For example, it can control a third-party device.
⑨	ALARM OUT	Alarm output interface. Output alarm signals.



NOTE!

For the latest specifications, see the product datasheet.

2 Mount Your Camera

The following figures are for your reference only. See the actual product for details. Mounting processes for dome cameras are similar, differences will be described separately if there is any.

Preparations

Check Before Mount

Check camera components

Before mounting your camera, check the device model, accessory types and quantities against the packing list to ensure components are complete.

Figure 2-1 Camera Structure

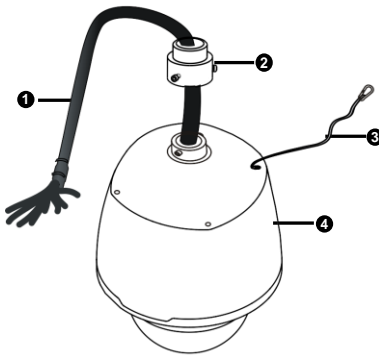

1: Tail cable	2: Bracket adapter	3: Safety wire	4: Dome
---------------	--------------------	----------------	---------

Verify the bearing capacity of the mounted position

Verify that the mounted position meets the bearing requirements. Otherwise, you are advised to reinforce the mounted position for the device weight. For more information, see the product datasheet.

Verify the lightning protection and grounding requirements

- Select proper lightning protection devices for the power supply, audio and video signals interfaces, and RS485 interfaces.
- See [Table 2-2](#) to ground the terminal properly.

Cable Requirements

Network cable

10/100 Mbps Ethernet CAT 5/5E UTP cables are applicable to the ANSI/EIA/TIA-568A/B and ISO/D.

Eight wires in the network cable need to be inserted in parallel into the top of the cable connector. The cable connector needs to be crimped in position. When the cable connector is in position, ensure that the metal pieces of the cable connector are parallel to each other and the clamp of the cable connector is intact.

Optical fiber

The optical module in the camera should match that of the third-party device (such as a switch), in terms of fiber mode and emission/receiver wavelength. Ensure the transmission distance of the optical module is greater than the distance actually required.



NOTE!

For a dome camera with optical module, it should be connected to the single mode optical fiber instead of multimode optical fiber.

For a proper optical fiber connection, check that:

- During SFP module installation, do not bend the fiber at sharp angle (make sure that the curvature of the fiber is greater than 90 degrees).

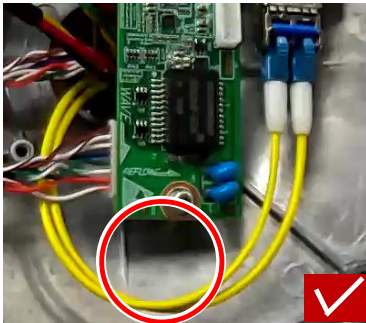

- When mounting the tail cable adapter, ensure that the optical fiber is not clamped by the device. Otherwise, the optical fiber could be damaged.
- Avoid excessively bending the optical fiber during installation. If the optical fiber is too long, coil the optical fiber. Ensure that the coil diameter is greater than 60 mm and the curvature is greater than 90 degrees.

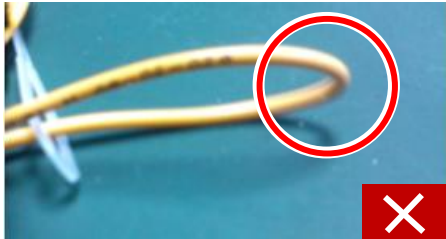

- Select a high-quality fiber connector. If a non-standard fiber connector without chamfering is used, internal ceramic sleeves such as the optical module, fiber optic adapter, or optical splitter could be damaged.
- Ensure that the fiber connector is in good condition, the latch is not disrupted and keeps elasticity, and the connection to the peer end is proper.



- Before connecting an optical fiber, check that there is no obvious surface defect such as stain, scratch, dent, or pit. If the fiber connector, fiber optic adapter, or optical module is dirty, clean it with alcohol and clean cotton (or a clean cotton rod).
- Choose a fiber optic adapter according to the fiber connector model. Use an optical splitter when cascading devices.

- To connect a fiber connector and a fiber optic adapter, align the fiber connector with the slot in the fiber optic adapter to ensure proper interconnection.



Power cable



NOTE!

Data listed in [Table 2-1](#) is applicable to power cables that use 24 VAC /24 VDC power supply. The item Core Diameter indicates the conductor diameter.

Table 2-1 Power Loss on the Cable for Different Lengths and Different Core Diameters

Core Diameter (Unit: mm)	Distance (Unit: m)			
	0.80	1.00	1.25	2.00
30	28	45	72	183
40	21	34	54	137

Distance (Unit: m)	Core Diameter (Unit: mm)			
	0.80	1.00	1.25	2.00
Power (Unit: W)				
50	17	27	43	110
60	-	22	36	91
70	-	19	31	78
80	-	-	27	68
90	-	-	24	61
100	-	-	21	55

Table 2-2 Phoenix Connector Description

Power Supply	Cable Color
<ul style="list-style-type: none"> IR PTZ dome (for long range illumination)/smart IR PTZ dome/laser PTZ dome/starlight white light PTZ dome/starlight full spectrum PTZ dome/starlight IR PTZ dome: 24VAC 3A/24VDC 2.5A IR PTZ dome (for short range illumination):24 VAC 2.2A/ 24 VDC 2.5A 	<p>The anode and the cathode are not distinguished for phoenix connectors of red and black cables.</p> <hr/> <p>GND: yellow-green color.</p> <p>Note: GND is used to ground the camera. Ensure that GND is connected to a reliable grounding point.</p>

Process Map

Make sure the camera is disconnected from power during installation.



NOTE!

- Accessories such as the wall mount bracket and the pendant mount bracket may be necessary during installation. For supported models, refer to the accessory list recommended by your dealer.
 - The wall bearing capacity and the bracket length must satisfy onsite mounting requirements. You need to select a mount mode according to the actual situations.
-

The following figure shows the mounting process.

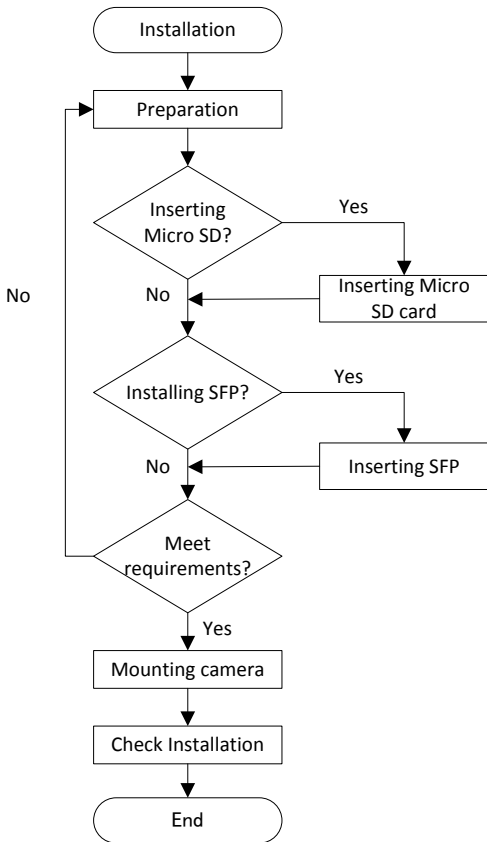

Hardware Installation

Insert the Micro SD Card (Optional)

To use the local storage function, you need to install a Micro SD card. The Micro SD card is installed inside the camera. Do not hot plug the Micro SD card after it is inserted. Otherwise the camera or the SD card might be damaged.



NOTE!

- Format the Micro SD card before using it. You can do the format job in the software interface.
- For recommended Micro SD card specifications, contact your dealer.
- The following figures are for your reference only. The Micro SD slot may vary with your camera.

Unscrew the four cross-recessed screws to remove the back cover. Insert the Micro SD card, and then mount the back cover. Properly mount the waterproofing ring in position.

Figure 2-2 Insert the Micro SD Card

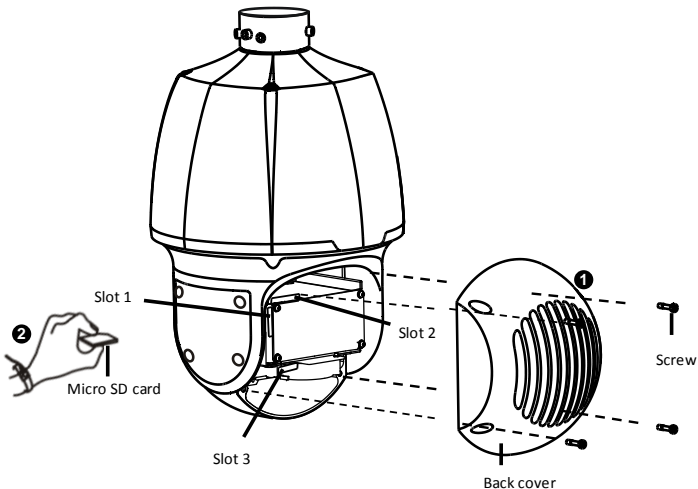

Table 2-1 Micro SD Card Slot Description

Model	Micro SD Slot
<ul style="list-style-type: none">• WDR IR PTZ Dome• Smart IR PTZ Dome	Slot 1
<ul style="list-style-type: none">• Laser PTZ Dome• IR PTZ Dome	Slot 2
<ul style="list-style-type: none">• Starlight White Light PTZ Dome• Starlight Full Spectrum PTZ Dome• Starlight IR PTZ Dome	Slot 3

Mount the SFP Optical Module



NOTE!

- Select the optical module by referring to the accessory list recommended by your dealer.
- During the connection, ensure that the optical fiber plug of the optical module matches the actual optical interface of the tail cable (referring to the tag attached to each optical interface).

1. Unscrew the tail cable adapter by loosening four screws.

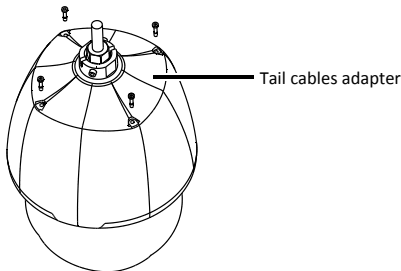

2. Turn over the tail cable adapter unit, and remove the dustproof lid.

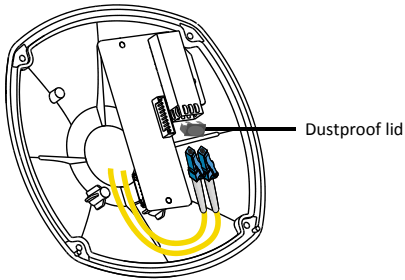

3. Insert the SFP optical module recommended by your dealer.

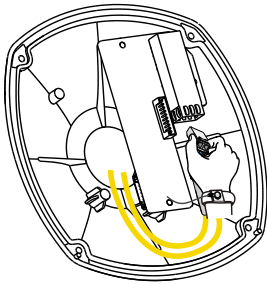

4. Connect the optical fiber plug to the SFP module, and then replace the tail cable adapter unit.

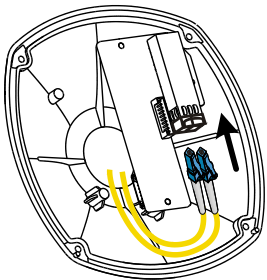

Mount the Camera

Wall Mount



NOTE!

- When mounting the camera, please install the bracket adapter to the bracket first and then mount the camera to the bracket.
 - Tighten all the screws to hold the dome securely.
 - For waterproofing, apply sealant between the dome and the bracket, wall veneer slits, and leading-out holes of the wall.
 - The following section describes concealed installation. To implement open installation, directly lead the cable out from the cable slot at the flank of the bracket.
 - The following takes wall mount as an example.
-

1. Position the drill holes and mark according to the bracket, and then lead the cables out of the wall.

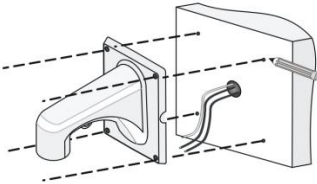

2. Drill holes on the wall. Use a drill bit that matches the diameter of plastic anchor, and refer to bolt length for hole depth.

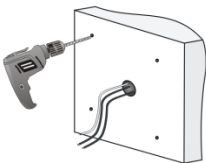

3. Knock in the expansion bolts and ensure that they are locked into place.

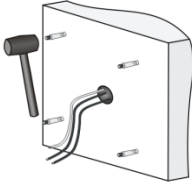

4. Turn the bracket adapter (G1 ½ male thread) in.

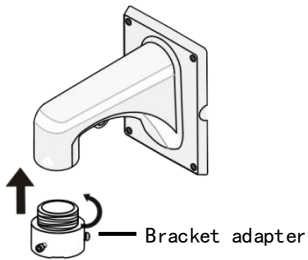

5. Secure the bracket adapter with a screw.

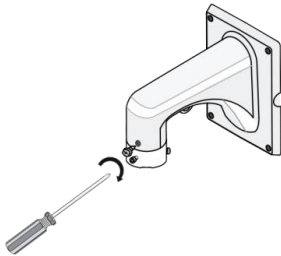

6. Attach the safety wire to the bracket and the dome. And Lead the tail cable through the bracket.

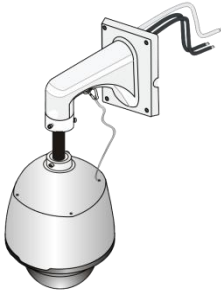

7. Attach the dome to the bracket adapter.

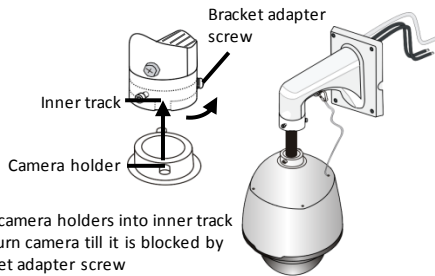

8. Secure the dome with two M5 screws.

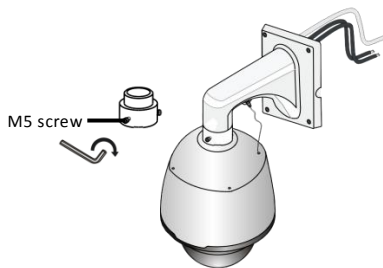

9. Connect the cables and attach the bracket to the wall with flat pads, washers and nuts.

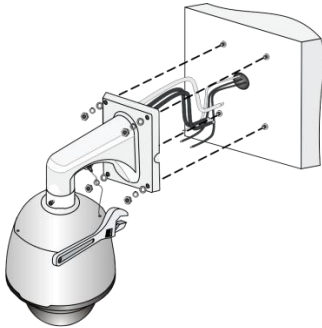

Pendant Mount



NOTE!

- The pendant mount bracket is for indoor installation only. For specially required outdoor installation, please make sure all waterproof requirements are met. We will not assume any responsibility for damage or loss incurred otherwise.
 - Any custom made pendant must conform to the waterproof requirements.
 - Tail cables should be protected by waterproof measurements and not be exposed. The whole wiring area of tail cables should be well waterproofed. Seal the connector of the dome camera and the pendant for waterproofing. Ensure that the sun shield on the tail cable unit is mounted in position.
 - When mounting the camera, please first install the bracket adapter to the bracket and then mount the tail cable unit to the adapter.
-

1. Locate the positions of the holes.
 - a. Mark the positions of the holes by referring to the mount points of the bracket.
 - b. Lead the cable through the hole on the wall.

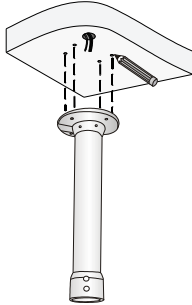

2. Select a drill bit matching the outer diameter of the expansion bolt. For the hole depth, refer to the bolt length.

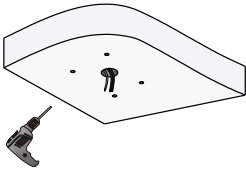

3. Knock the expansion bolts, and verify that they are tightened up.

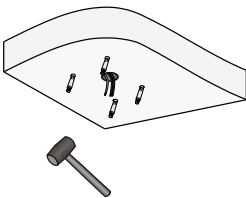

4. Screw-in the bracket adapter (G1 ½ male thread) to the connector of the pendant mount bracket.



5. Tighten the screws (M4) at the bracket.

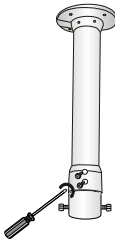

6. Mount the dome and connect all the tail cables (see step [6](#), [7](#), [8](#) in [Wall Mount](#)).

Start the Camera

After you have mounted the camera properly, connect the camera to power.

Each time the camera is powered on, it will perform a self-test to check the Pan/Tilt/Zoom (PTZ) function). After self-test, you can operate the camera.



NOTE!

- The self-test process starts after the camera is powered up. Please wait patiently.
 - When the operation temperature is lower than zero degree Celsius, the camera will be automatically pre-heated (the pre-heat process takes 30 minutes at most). The self-test starts only after the temperature rises above zero degree Celsius.
-

Reset the Camera to Default Settings

Remove the back cover first. For the camera structure, see [Figure 2-2](#). Press and hold the RST button (as shown in the figure below) for about 15 seconds to restore factory default settings. The RST button only works within ten minutes after the camera is powered on. The camera is restored to the default settings after the startup.

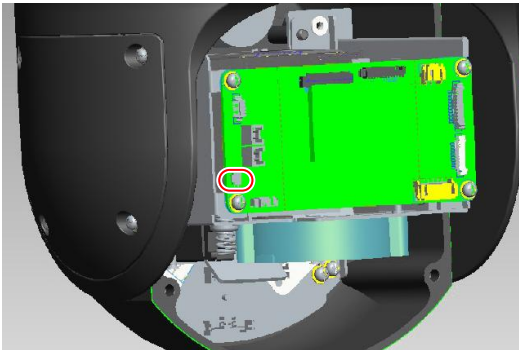

Waterproof Measures

Waterproof Components for an RJ45 Plug

1. Attach the seal ring to the copper interface.

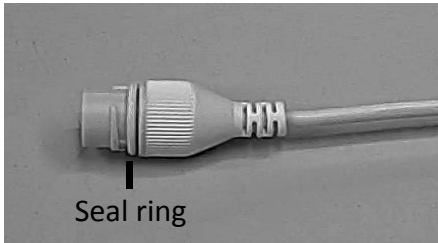

2. Mount the waterproof components.

You can crimp the inner wires of the cable with the RJ45 plug first and then cover the waterproof components. You may also cover the waterproof components first.

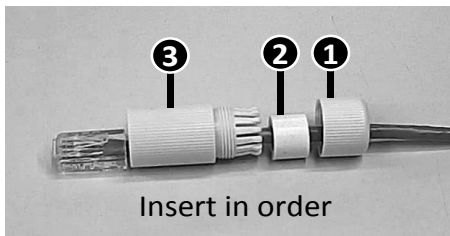

3. Insert the cylindrical waterproof ring into bolt.

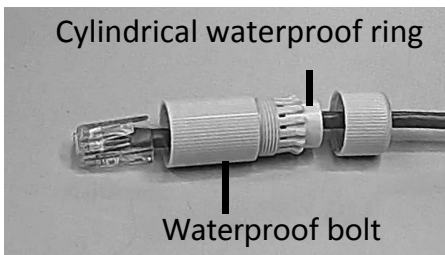

4. Insert the cable into the Ethernet interface and screw the waterproof bolt in.

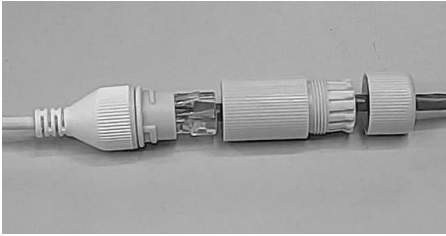

5. Screw in the waterproof bolt lid.

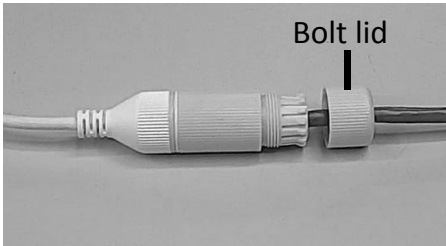

6. Finish the waterproof installation.

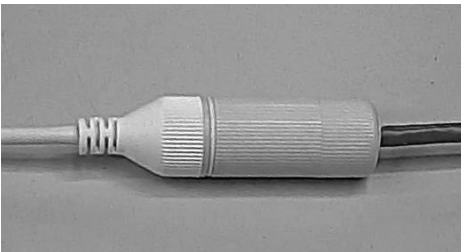

Waterproof Tail Cable

Connect the tail cables and then take the following steps to protect the tail cables from water using waterproof tapes. The following figures are for your reference only.

1. Connect the tail cables.

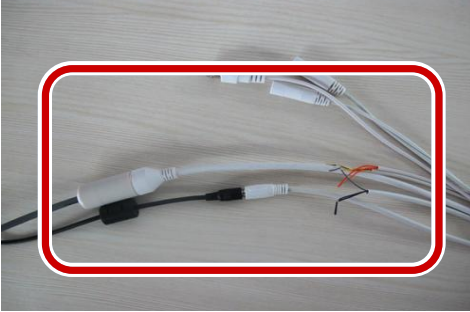

2. Protect the connected cables using insulating tapes.



3. Protect other cables using insulating tapes.



4. Wrap all the tail cables together using insulating tapes.



5. Choose a start point for waterproof tapes.



6. Protect the tail cables using waterproof tapes.





CAUTION!

- Avoid short circuit when insulating the cables.
 - Use self adhesive waterproof tapes that will stick together with the twisted cables.
 - Tighten waterproof tapes when wrapping the cables and make sure the cable connections are fully covered.
 - You are recommended to put the waterproof cables in a waterproof junction box which needs to be purchased separately.
-

3 Set Your Camera over the LAN

To view and configure your camera via the local area network (LAN), you need to install the EZStation to find your camera and change its IP address.



NOTE!

- Please contact your dealer to obtain the EZStation.
 - Please refer to the user manual of EZStation for detailed information.
-

1. Connect your camera and your PC as shown in the figure below to ensure the routing is available.



2. Use EZStation to search online cameras automatically.
3. Modify the camera settings if necessary, including its IP address and subnet mask.



NOTE!

- The default IP address is “192.168.0.13”. The default username is “admin”, and the default password is “123456”.
 - To access your camera from a different subnet, set the gateway for your camera after you log in.
-

4 Access Your Camera

For an IP camera, you can directly control and manage it through the web interface on a PC.

System Requirements for Your PC

Item	Requirements
Operating system	Microsoft Windows 8/Windows 7/Windows XP (32-bit or 64-bit). Microsoft Windows 7 (32-bit) is recommended.
CPU	2.0 GHz or higher, dual-core. Intel i3 CPU or higher are recommended.
Memory	At least 1 GB. 2 GB (or higher) is recommended.
Graphic card	At least 128 MB display memory. Mainstream discrete graphics with more than 1 GB display memory are recommended. The hardware should support DirectX9.0c. Note: Make sure that the latest driver is installed on graphic card.
Sound card	Required. Note: Two-way audio and voice broadcast require the latest driver on sound card.
Network card	Gigabit Ethernet network cards (or higher) are recommended.

Access Your Camera

Before you begin, check that:

- The self-test is finished.

- Your camera is operating properly and connected to the network.
- The PC client you are using is installed with Internet Explorer 8.0 or later.

Follow these steps to access your camera through the Web interface:

1. Open your browser, input the IP address of your camera (default IP is 192.168.0.13) in the address bar and then press **Enter** to open the login page.
2. Enter the username (default is “admin”) and password (default is “123456”) and then click **Login**.



NOTE!

Install the ActiveX at your first login. For the detailed steps, see [Install the ActiveX](#). When the installation of the ActiveX is completed, open your IE to log in.

Install the ActiveX

The following takes the IE browser as an example to describe the installation steps.

1. Click **Download**.



Failed to load ActiveX control, click [Download](#) to install latest ActiveX control.

2. Click **Run**. You may also click **Save** to download the file to your computer first.
3. Close the browser and follow the steps to complete the installation.



NOTE!

- For your first login with Windows 7, if the system does not prompt you to install ActiveX, follow these steps to turn off UAC: click the **Start** button, and then click **Control Panel**. In the search box, type **uac**, and then click **Change User Account Control Settings**. Move the slider to the **Never Notify** position, and then click **OK**. After UAC is turned off, log in again.
 - If the installation failed, open **Internet Option** in IE before login. Click the **Security** tab, click **Trusted sites**, and then click **Sites** to add the website. If you use Windows 7, you need to save the setup.exe to your PC first, and then right-click the file, select **Run as administrator**, and then install it according to instructions.
-

Adjust the Display

Enter the live view page, and then click the **Zoom** and **Focus** buttons to get clear image.

BOM: 3101COBX